



AQUIND Limited

AQUIND INTERCONNECTOR

Consultation Report – Appendix 1.1E Non-Statutory Consultation – Non-technical Summary Document

The Planning Act 2008

The Infrastructure Planning (Applications: Prescribed Forms and Procedure) Regulations 2009 – Regulation 5(2)(q)

Document Ref: 5.1.1E

PINS Ref.: EN020022

AQUIND Limited

AQUIND INTERCONNECTOR

Consultation Report – Appendix 1.1E Non-
Statutory Consultation – Non-technical
Summary Document

PINS REF.: EN020022

DOCUMENT: 5.1.1E

DATE: 14 NOVEMBER 2019

WSP

WSP House

70 Chancery Lane

London

WC2A 1AF

+44 20 7314 5000

www.wsp.com



UK – FRANCE HVDC INTERCONNECTOR

Non-Technical Summary

Version 1 – December 2017



Contents

1	Introduction	3
2	The benefits of the project.....	5
3	About the project.....	6
	<i>Project description.....</i>	<i>6</i>
	<i>Operation and maintenance</i>	<i>11</i>
	<i>Summary.....</i>	<i>12</i>
4	Site and cable route selection.....	13
	<i>Terrestrial infrastructure in the UK.....</i>	<i>13</i>
	<i>Terrestrial infrastructure in France.....</i>	<i>16</i>
5	The permit granting process	20
	<i>Required consents</i>	<i>20</i>
6	Potential environmental impacts.....	22
	<i>Environmental impacts in the UK</i>	<i>22</i>
	<i>Terrestrial EIA.....</i>	<i>22</i>
	<i>Marine EIA.....</i>	<i>25</i>
	<i>Environmental impacts in France</i>	<i>27</i>
	<i>Cumulative and cross-boundary impacts.....</i>	<i>27</i>
7	Consultation	28
	<i>Approach to consultation.....</i>	<i>28</i>
	<i>Approach to consultation in the UK.....</i>	<i>28</i>
	<i>Consultation events</i>	<i>30</i>
	<i>Approach to consultation in France.....</i>	<i>31</i>
8	Project status and next steps	32

1 Introduction

- 1.1 AQUIND Interconnector is a proposed High Voltage Direct Current (HVDC) subsea and underground electric power transmission link between the south of England and Normandy in France with the capacity to transmit up to 2,000 MW¹ of electricity.
- 1.2 An indicative location of AQUIND Interconnector can be seen in Figure 1 below.

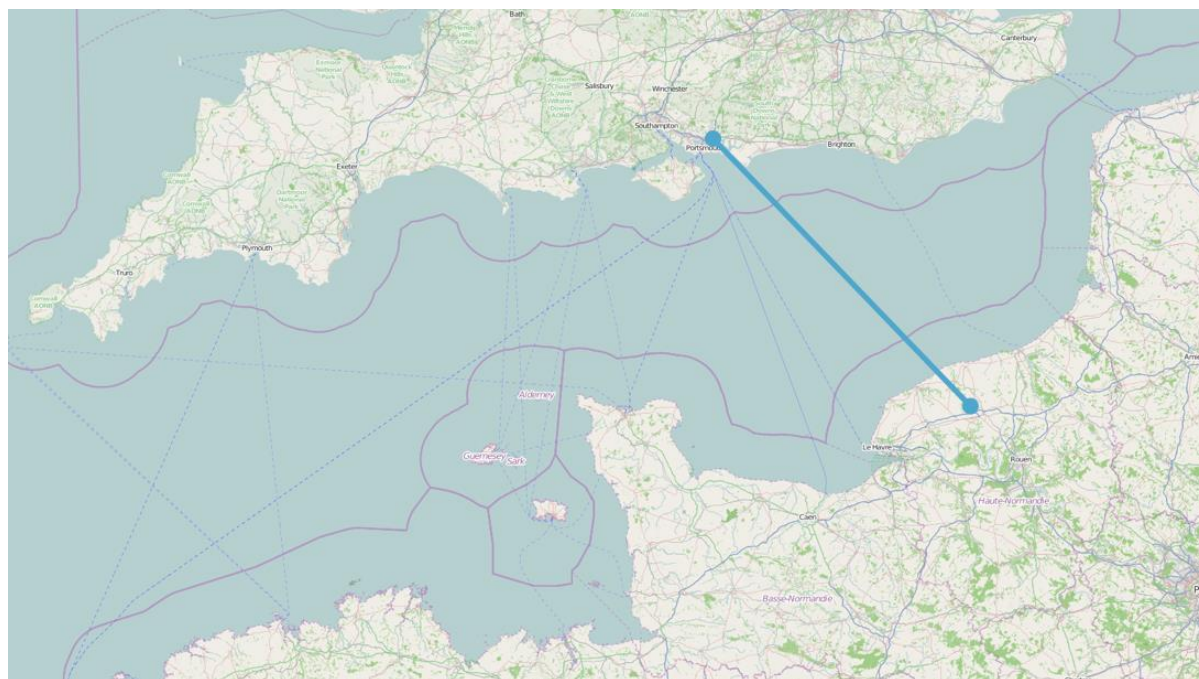

Figure 1 – AQUIND Interconnector between the UK and France – indicative location

- 1.3 The project is being developed and promoted by AQUIND Limited (AQUIND), a UK-registered company with the sole business of developing AQUIND Interconnector. AQUIND is not associated with any UK or European utilities or national electricity transmission system operators. AQUIND Interconnector is being developed as a private project without government subsidies.
- 1.4 AQUIND Interconnector is a candidate project for ‘Project of Common Interest’ (PCI) status under The Regulations for the trans-European energy infrastructure (EU 347/2013) (‘TEN-E Regulations’). The European Commission published its third list of

¹ AQUIND Interconnector will comprise two independent symmetrical monopole HVDC links (“poles”). Subject to final approvals, each pole will have the export capacity of 1,037.5 MW and the import capacity of around 1,000 MW, net of transmission and conversions losses with the total import capacity of up to 2,000 MW. Throughout this document, AQUIND Interconnector’s capacity is referred to as 2,000 MW.

PCI's in November 2017 which included AQUIND Interconnector. This list is to be approved by the European Parliament in Q1 2018.

- 1.5 PCIs are necessary to achieve the EU's energy and climate policy objectives. The TEN-E Regulation provides guidance for streamlining, co-ordinating and accelerating the permit granting process for PCIs and enhancing public awareness and involvement.
- 1.6 To be eligible for the PCI status, a project must be located in an energy infrastructure priority corridor and its overall benefits must outweigh its costs. It must have a significant impact on at least two EU countries, be located in one of them and cross the border of the other.
- 1.7 The project will be able to
 - Boost energy price competition by providing access to wider electricity markets;
 - Help improve security of supply by creating additional source of supply and by providing ancillary services to the respective national grids; and
 - Increase sustainability of energy supply by helping to integrate more renewable energy sources in the energy systems of the connected countries.
- 1.8 PCIs are required to adhere to certain application and consultation procedures which are provided by the TEN-E Regulations. The TEN-E Regulations sit alongside the national planning and consenting regimes of the countries where the project is located.
- 1.9 Under Annex VI.6(b) of the TEN-E Regulations, AQUIND is required to produce and publish a Non-Technical Summary. This describes the project and sets out its likely environmental effects and how they will be mitigated.
- 1.10 As required by the TEN-E Regulations, this document reflects the current status of the project and will be regularly updated as development progresses.
- 1.11 This first issue of the Non-Technical Summary will focus on the elements of AQUIND Interconnector within UK jurisdiction, but it also contains limited information about the part of the project within French jurisdiction. This Non-Technical Summary will be updated in due course to include further information about the elements of AQUIND Interconnector in France.

2 The benefits of the project

- 2.1 AQUIND Interconnector supports the European Commission’s aim of creating an integrated European energy market and meeting the EU’s energy policy objectives of affordable, secure and sustainable energy supply.
- 2.2 Great Britain (GB) currently has four operational bi-directional interconnectors with neighbouring countries and several more projects under the development.² These interconnectors provide a means of transferring electricity between connected countries. The challenges faced by Great Britain and the wider European energy system drive the need for additional interconnectors.
- 2.3 By linking GB and French electricity power grids, AQUIND Interconnector will make energy markets more efficient, improve security of supply and enable greater flexibility. The interconnector will also contribute to the reduction of CO₂ emissions by helping to integrate more renewable energy sources and, thus, reducing the reliance on fossil fuel power generation plants. It will help power grids evolve to adapt to changes in power generation sources and demand trends.
- 2.4 AQUIND Interconnector can also provide various ancillary services to the national system operators in both countries to help ensure safe and reliable operation of national electricity transmission systems.
- 2.5 Further information about AQUIND Interconnector and its benefits can be found on the following project website:
- In English: <https://aquindconsultation.co.uk>
- 2.6 The web address of the French consultation website will be provided in future revisions of this Non-Technical Summary once the French website goes live.

² For more information see <https://www.ofgem.gov.uk/electricity/transmission-networks/electricity-interconnectors>

3 About the project

Project description

- 3.1 AQUIND Interconnector is an underground and subsea electricity interconnector. The interconnector will consist of two poles with the capacity of 1,037.5 MW at the point of export from a national transmission system and approximately 1,000 MW at the point of import (i.e. net of transmission losses) each. The interconnector will use HVDC to transmit electricity from one end to the other. Since national transmission systems normally use alternating current (AC), a converter station transforming one current into the other will need to be built on each end. The converter stations will be connected with AC cables to already existing 400 kV substations, operated by National Grid in GB and RTE in France. In total, four HVDC cables will run between HVDC converter stations in France and England. The main elements of AQUIND Interconnector can be seen in Figure 2 below. The project will also include smaller diameter fibre optic data transmission cables laid together with electricity cables.

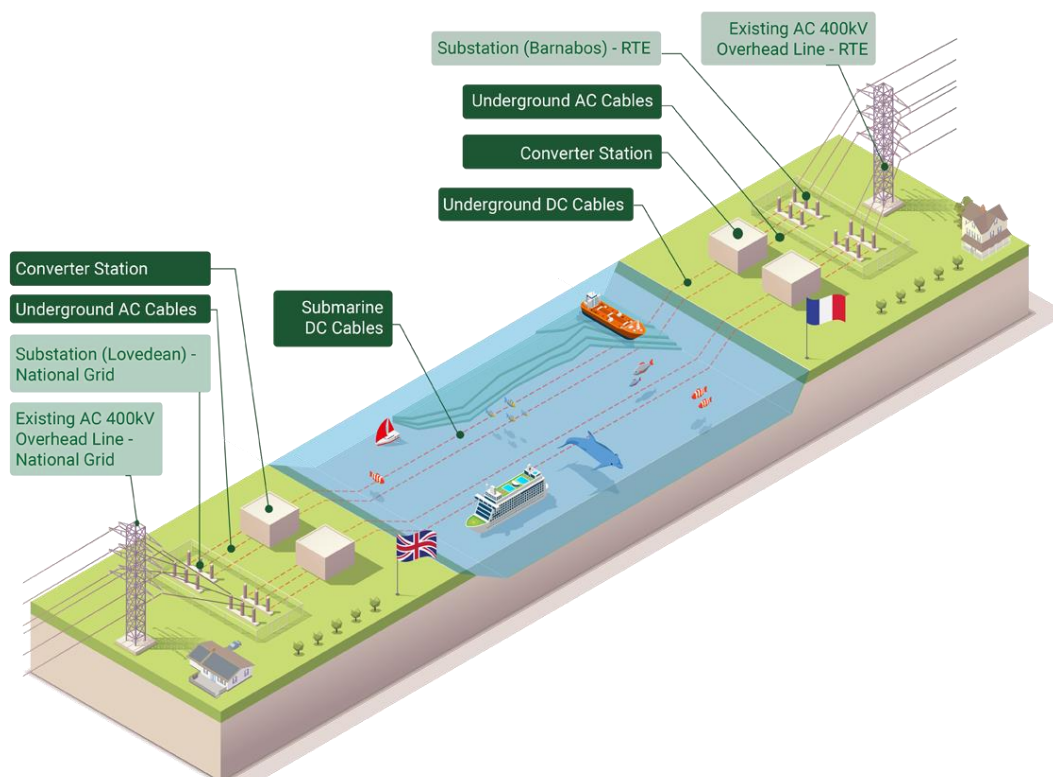

Figure 2 – The main elements of AQUIND Interconnector

- 3.2 The GB and French electricity grids both use an AC system. However, HVDC is a more appropriate technology for the transmission of power over longer distances. HVDC has lower transmission losses and HVDC cables are relatively easier to build and install. AQUIND Interconnector will use a more advanced Voltage Source Converter (VSC) technology for the converter stations, which would enable the interconnector to switch

the direction of electricity flows very quickly. VSC-based interconnectors can also provide a range of ancillary services to national transmission systems.

Offshore elements

3.3 The offshore (marine) elements will comprise four submarine cables between the UK and France, which can be bundled in pairs, and smaller diameter fibre optics cables for data transmission. The offshore cable route can be divided into the following sections:

- Approximately 47 km within the UK territorial limit, i.e. 12 nautical miles from shore;
- Approximately 53 km from the UK territorial limit to the boundary of the Exclusive Economic Zone (EEZ);
- Approximately 58 km from the boundary of the EEZ to the French territorial limit;
- Approximately 29 km within the French territorial limit, i.e. 12 nautical miles from shore.

UK elements

3.4 In the UK, the following terrestrial elements are proposed:

- Works at the existing National Grid Lovedean substation in Hampshire where AQUIND Interconnector will connect to the existing GB grid.
- AC underground cables, connecting Lovedean substation to the proposed nearby converter station;
- The construction of the converter station comprising a mix of buildings and outdoor electrical equipment. The building roofline will vary in height but will approximately be 22 m at its peak (a diagram showing the main elements of the structure is shown in Figure 4 below);
- Underground cables from the proposed landfall site in Eastney (near Portsmouth) to the converter station at Lovedean, approximately 20 km in length. The intention is to locate the cables within existing highways or road verges where practicable.

French elements

3.5 In France, the following terrestrial elements are proposed:

- Réseau de Transport d'Électricité (RTE) will carry out the required substation works at the existing Barnabos substation in Normandy;
- The French AC cable planning and installation to be undertaken by RTE;
- The proposed new converter station near Barnabos substation, which will be similar in nature to its UK equivalent;
- Onshore underground cables from the landfall on the French shore to the substation in Barnabos, approximately 35 km in length. It is proposed that the landfall site in France will be near Dieppe or Pourville-sur-Mer. The exact location will be confirmed, based on further assessments of environmental and technical constraints.

- 3.6 The individual components of AQUIND Interconnector are explained in more detail below.

Converter stations

- 3.7 As described above, to transmit electricity between GB and France, a converter station is needed in each country to convert electricity from direct current (DC) to alternating current (AC) and vice versa. A short length of AC cables will connect the converter station to the National Grid and RTE substations. It is anticipated that approximately 6 to 9 hectares of land will be required for the converter stations in both the UK and in France. This includes the areas required for the converter station buildings, outdoor electrical equipment and screening measures. The exact locations of the converter stations near Lovedean and Barnabos are still to be confirmed (for more information on the site selection process see section 4 below).
- 3.8 The interconnector, which has a nominal capacity of 2,000 MW³, will link the transmission networks of Réseau de Transport d'Électricité (RTE) and National Grid Electricity Transmission (NGET). Two independent 1,000 MW symmetrical monopole links are planned; each operating at ± 320 kV. The interconnector will use the latest Voltage Sourced Converter (VSC) technology, to provide enhanced ancillary services on both AC networks.

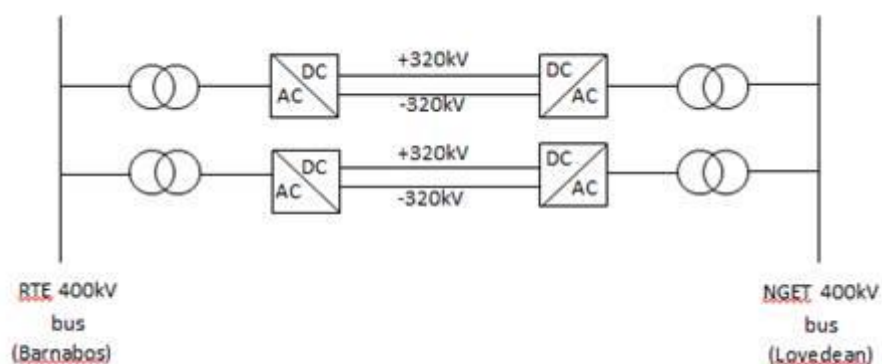

Figure 3 – AQUIND Interconnector's Symmetrical Monopole Arrangement and Voltage Levels

- 3.9 Voltage Source Technology (VSC) technology has now become the preferred HVDC technology for applications in Europe. VSC is capable of fast power reversal (in milliseconds) and results in reduced power losses in the connected transmission network.

³ When link capacity is referred to as 2,000 MW (or 2 x 1,000 MW links), this is a nominal figure, however in order to maintain a transmission entry capacity of 2,000 MW, we are requesting 2,075 MW to be delivered (taking losses into consideration).

VSC also has a smaller site footprint requirement with typically 50-60% of the site area which would be required for an equivalent scheme of the same rating using another technology.

- 3.10 Figure 4 below indicatively shows the main elements of the converter station, including the converter hall, control and spares buildings, lightning masts and lighting columns.

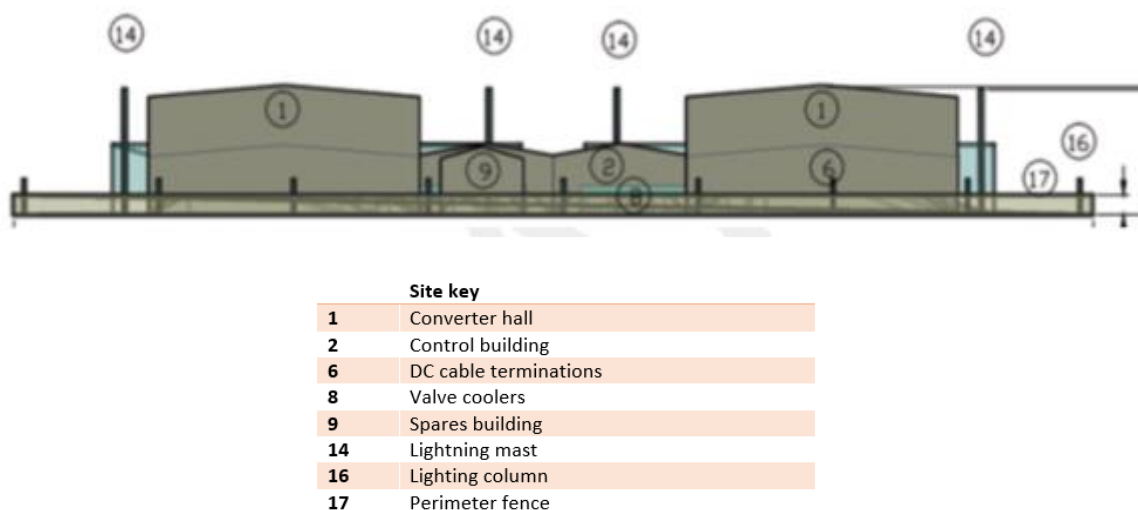

Figure 4 - Main elements of the converter stations

- 3.11 A converter station typically consists of a steel frame and cladding. Landscaping may be incorporated around the perimeter of the site to help integrate the converter station into the surrounding environment.
- 3.12 The outdoor equipment located within the converter station will be similar to equipment typically found within electrical substations, such as National Grid's adjacent Lovedean substation. Converting power between AC and DC requires additional equipment which will be housed within the converter station buildings together with associated infrastructure for cooling and control.
- 3.13 According to the current programme, construction of the converter stations will be undertaken over a period of approximately three years commencing in late 2019, with the converter stations fully commissioned in 2022.

Cables

- 3.14 AQUIND Interconnector will use HVDC underground and submarine cables to transmit electricity between the converter stations and HVAC underground cables to connect the converter stations to the substations. The project will also include smaller diameter fibre optic data transmission cables, which are used for communication.

High Voltage Direct Current (HVDC) cables

- 3.15 There will be four DC cables which can be bundled in pairs, each within a separate trench. The cables will have a copper or aluminium conductor insulated using crosslinked polyethylene (XLPE). XLPE is the leading HV cable technology and has a reduced environmental impact as it does not use oil.
- 3.16 The marine route will be approximately 190 km in length. Cables will be laid within trenches on the sea floor or, where trenches cannot be excavated, laid on the seafloor and protected using alternative protection systems. The cables will be installed using a cable lay vessel (or barge) and will be pulled overboard, under tension, to the seabed. The final installation method will be confirmed following further marine surveys.
- 3.17 The onshore DC cables will preferably be installed within roads or road verge to reduce environmental impacts and avoid the need to affect private land. The terrestrial DC cables take up a considerably narrower corridor compared to AC cables. Therefore, it is favourable to maximise their usage over AC cables, by locating the converter station as close as possible to the substation.

High Voltage Alternating Current (AC) cables

- 3.18 The AC cables will be laid between the new converter stations and the substations in each country.
- 3.19 The 2,000 MW connection can be achieved with two circuits into each substation. Given that each circuit will require one cable (or two) for each conductor phase (total of three phases), at least six (or twelve)⁴ AC cables will be required to connect the proposed converter stations to the existing substations. The cable quantity will be confirmed once the final converter station location is confirmed.
- 3.20 The configuration of the AC cables will be subject to detailed design and may be impacted by soil conditions, length of cable route, impact from the environment and existing infrastructure.
- 3.21 Figure 5 below shows the typical terrestrial cable installation process for an onshore cable and a subsea cable.

⁴ Depending on distance between converter station and substation



Figure 5 – The underground cable installation process and an example image of an HV subsea cable

Fibre Optic (FO) cables

- 3.22 A fibre optic cable used for protection, control and telecoms will be installed together with power cables.
- 3.23 For the offshore elements, the fibre optic will be bundled with the power cables. Onshore, a small diameter duct will be installed between the power cables. In both cases, the FO does not increase the cable corridor width.

Landfalls

- 3.24 The subsea and land cables need to be connected (jointed) together at a landfall location. The landfalls need to be located very close to the sea shore and include an underground transition joint bay (TJB), where the two different cable types are jointed together. The exact locations for the TJBs in both countries are still to be determined, but they will be at Eastney in the UK and either Dieppe or Pourville-sur-Mer in France.

Operation and maintenance

- 3.25 The project will have a design life of 40 years with control system overhauls typically conducted every 10-15 years of operation. Major items of plant are designed to meet the lifetime of the scheme. After approximately 25 years, the onshore control system and converter technology is normally updated and overhauled. This is a considerable investment but will ensure that the interconnector can operate efficiently throughout the remainder of its life.
- 3.26 If appropriate, the converter stations could be decommissioned in accordance with current recycling and waste disposal regulations. It is foreseen that the marine cables will be decommissioned as per the industry norm i.e. left on the seabed. When decommissioning the onshore cables, every effort would be made to recycle as much material as possible.

- 3.27 The converter stations will be designed for unmanned operation, but a small team of maintenance staff (typically 3-4 in each country) will be responsible for maintaining the plant and will be on 24/7 callout if required.
- 3.28 The onshore and offshore cables will not require any maintenance, but cable failures or damage to cables can occur. Onshore cable damage would typically leave the interconnector out of service for two weeks during repair, while offshore cable damage would typically take two months or more to repair, subject to vessel availability and weather conditions.
- 3.29 Typically, an HVDC interconnector will achieve an availability of 95-98%. For the remaining 2-5% of the time, the interconnector will be under planned outage. Planned outages take place on an annual basis and usually last between 2-5 days. Forced outages occur when parts of an interconnector fail. The majority of forced outages last for only a few hours but may take several weeks to be resolved in the worst case scenario (i.e. a cable fault).

Summary

- 3.30 Table 1 below summarises key locations, dates and technical data for the project.

Table 1 – Key project information

Power Capacity	2,000 MW – 2,075 MW	Planned Final Investment Decision Date	To be confirmed
Interconnector route length	Total route – approx. 245 km	Planned Energisation and Commissioning Date	Pole 1 Q3 2022; Pole 2 Q4 2022
GB Landfall Location	Eastney, Portsmouth	Planned Commercial Operations	2022
GB Converter Location	Lovedean, north of Waterlooville	HVDC Converter Technology	Voltage Source Converter (VSC)
French Landfall Location	In the vicinity of Dieppe or Pourville-sur-Mer	HVDC Cable Technology	XLPE
French Converter Location	Barnabos, Normandy	HVDC Operating Voltage	320kV

4 Site and cable route selection

- 4.1 Detailed assessments have been carried out to identify suitable landfall and connection points in the south of England and the north of France. The assessments have considered the capacity of the network, proximity to the coast and other economic and environmental issues.

Terrestrial infrastructure in the UK

Connection point

- 4.2 The connection point was identified through a feasibility study and using the “Connection and Infrastructure Options Note” (CION) process, performed by National Grid.
- 4.3 CION evaluates the respective transmission options required leading to the identification and development of the most efficient, coordinated and economical connection point. The process also helps develop the onshore connection design and where applicable, offshore transmission system/interconnector design. This is done in line with the obligation to develop and maintain an efficient, coordinated and economical system of electricity transmission.
- 4.4 The CION process uses National Grid’s knowledge of the network (including agreed future connections), agreed cost information and data supplied by the developer (AQUIND) to make the assessment.
- 4.5 The CION process for AQUIND Interconnector ultimately identified Lovedean as a connection point that best meets the above objectives.

Landfall optioneering and cable route

- 4.6 The landfall optioneering informed the cable selection process as the location of the landfall influences the length and routing of the cable. The landfall options were therefore considered with regard to the following:
- Distance from substation
 - Ease of installation from beach landing to substation
 - Suitability of approach (marine constraints)
 - Future development and local activity
 - Beach composition and stability
 - Cable requirements
 - Environmental constraints
- 4.7 As a result of the site selection process, Eastney has been identified as the preferred landfall location in the UK, and Lovedean substation near Waterlooville as the preferred connection point to the National Electricity Transmission System (NETS).

- 4.8 It is proposed to bury the HVDC cables in the existing highway network, where practicable. Figure 6 shows the proposed HVDC cable route from Eastney to Lovedean, which will be approximately 20 km long.
- 4.9 The proposed 400 kV HVAC cable route will pass through agricultural land to facilitate the connection between the existing National Grid Lovedean substation and the new converter station. As AC cables require a much wider corridor, the AC route has been kept as short as practicable, to minimise disruption.



Figure 6 - Proposed cable route from Eastney to Lovedean in the UK

Converter station

- 4.10 The exact location of the proposed converter station near Lovedean substation is still to be confirmed, subject to further environmental surveys and technical requirements. The converter station will either be located to the south (option A) or to the west (option B) of the existing substation. The two options are shown in Figure 7 below, with the existing substation shown in purple, option A shown in blue and option B shown in green.

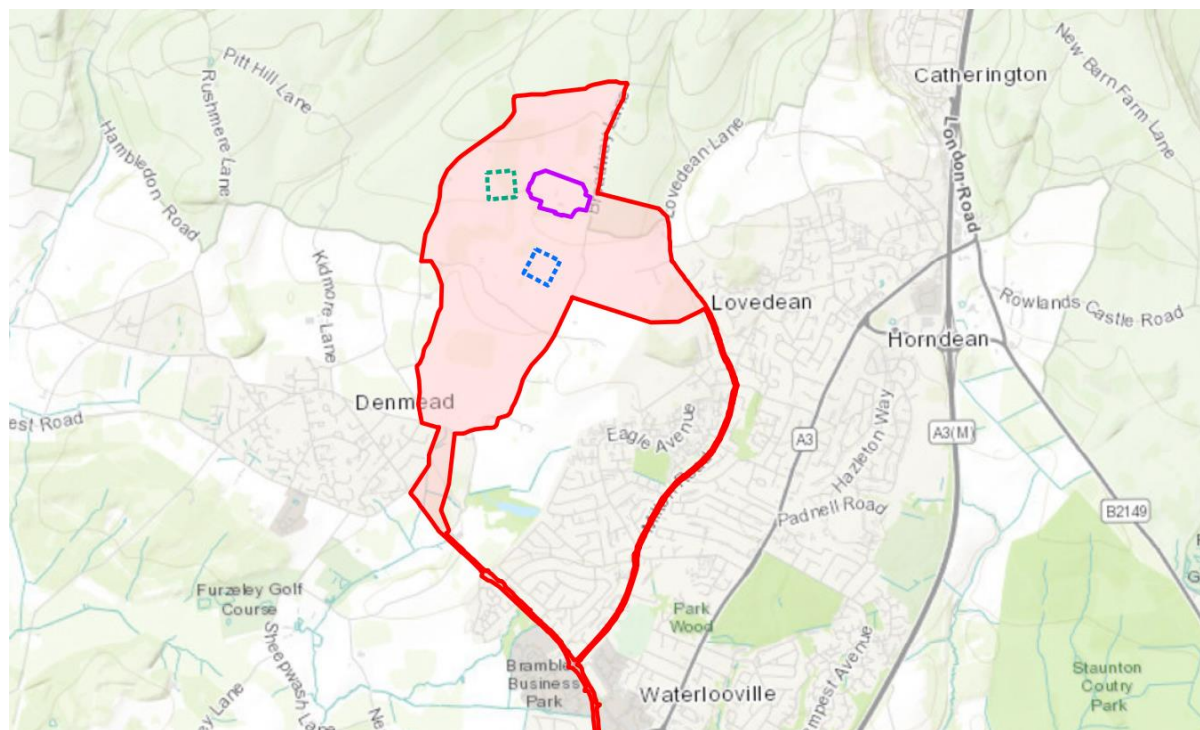

Figure 7 - Converter station site options A (blue) and B (green)

- 4.11 Site option A to the south of Lovedean substation benefits from being close to an existing access road (Broadway Lane). However, it requires a longer length cable connection to Lovedean substation. This option is likely to require a larger number (12) of HVAC cables due to the existence of existing 132kV oil filled cables which exit the substation to the south.
- 4.12 Site option B benefits from the existing mature hedge lines which provide natural screening from the South Downs National Park. Six AC cables would be required to connect the converter station to Lovedean substation.
- 4.13 A new permanent access road will be established. This road will be utilised throughout construction; however it will continue to be required for maintenance staff to access the site. Access by maintenance staff will be limited to light vehicles. Use by heavy vehicles will only be required in the rare event of building damage or a major equipment failure, for example if a transformer needs to be replaced at the converter station.

Terrestrial infrastructure in France

Connection point

- 4.14 Following feasibility studies conducted by RTE and initial landfall/cable route desktop studies, Barnabos substation was identified as the preferred point of connection to the French transmission network.
- 4.15 Other substation locations were discounted because of technical and environmental constraints at associated landfall locations, constraints on the surrounding electrical network and considerably longer DC cable route options. AQUIND has subsequently signed a Technical and Financial Proposal (PTF) with RTE which has informed the landfall, cable route and converter station selection and development.

Landfall and cable route

- 4.16 A French landfall optioneering exercise was undertaken to identify the best site to facilitate the installation of the subsea cables into shore. Following an initial landfall feasibility study, and AQUIND's acceptance of the PTF at Barnabos, numerous locations were identified for investigation and the following points were considered:
- Landfall site – available space for onshore construction, space for offshore installation, presence of bedrock at shallow depth, construction access and routing to a main road for cable installation;
 - Marine approach – water depth and seabed conditions;
 - Environmental constraints – impact on hydrology, traffic, transport, noise and vibration and local ecology;
 - Environmental designations.
- 4.17 After evaluating local constraints (including the presence of the Espace Remarquable du Littoral (ERL) along much of the French coast under consideration), Pourville and Dieppe have been identified as possible options for bringing the subsea cables to shore.
- 4.18 In conjunction with the landfall optioneering exercise, AQUIND is also undertaking a detailed cable routing study to identify the best cable route from the landfall to Barnabos substation.
- 4.19 The indicative total length of the cable route is 35 km.

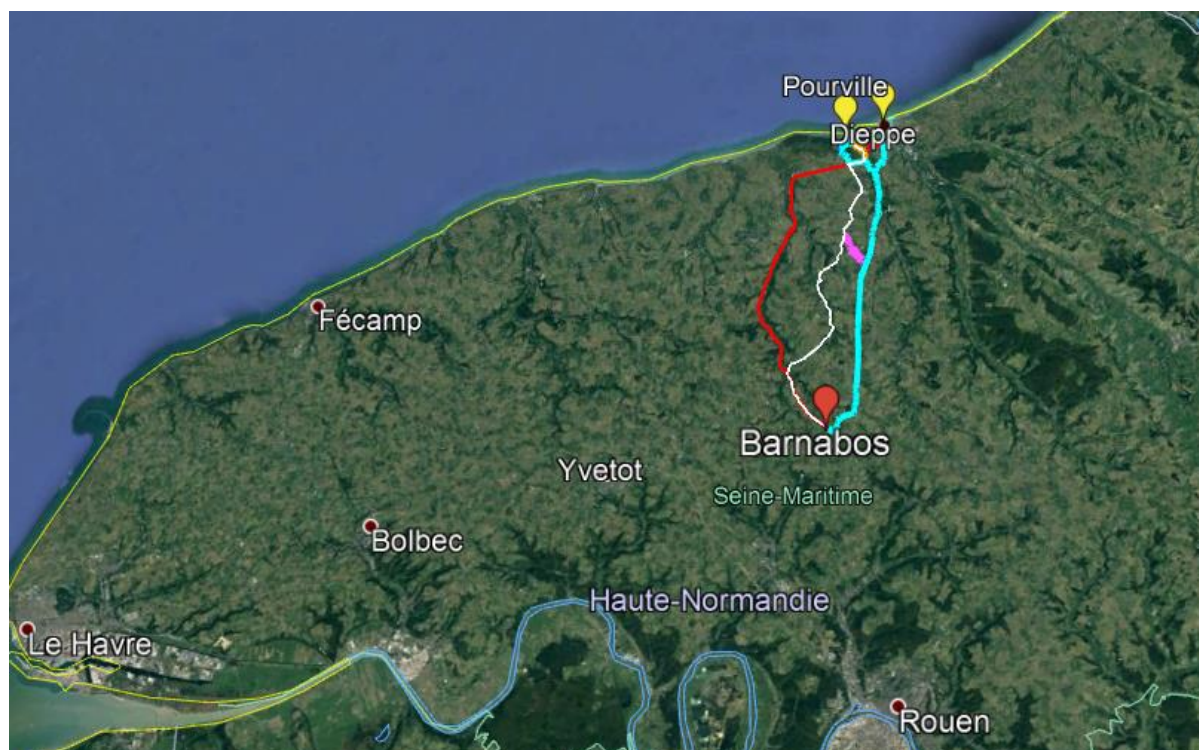

Figure 8 – Final study areas for landfall site and cable route in France

4.20 The final selection of the landfall site and cable route will be based on further assessment of environmental and engineering constraints.

Converter station

4.21 AQUIND is also currently undertaking an optioneering process to identify the converter station location at Barnabos. This process will determine the best location given the following constraints:

- Proximity to dwellings – AQUIND is conscious of the needs of the local community. Determining the exact location of the station and designing appropriate landscaping will help limit any impact as much as practicable.
- Existing overhead and underground cables – The existing substation has multiple overhead power cables exiting the station, must be considered before the construction of the converter station.
- Ground topology – The area around Barnabos is predominantly flat. The volume of earth excavation (cut) and resituating (fill) is being modelled, to reduce the environmental impact of the development.
- Flood risk – Flood risk will be assessed in the area around Barnabos to determine the frequency of flooding in the area. These studies will determine the platform height.

4.22 The converter station will be located within 2 km of Barnabos substation, inside the envelope presented in the figure below.



Figure 9 – Indicative search area for the Converter Station

Offshore cable corridor

4.23 As with the terrestrial cable route, the final offshore (marine) cable route is yet to be determined. Following engineering and environmental constraints mapping, a cable corridor has been identified that connects likely landfall locations in the UK and France.

4.24 Extensive marine studies and investigations (benthic, geophysical, search for unexploded ordnance) are being undertaken to confirm the cable route for the project within the corridor described, the depth at which the cables will be buried, and the technology that will be deployed. The latter is dependent on ground conditions on the seafloor being conducive to meeting target cable burial depth. A geotechnical survey and a number of pre-construction surveys will be undertaken at a later stage.

The marine surveys are performed with attention to such aspects as local fishing activity, marine archaeology, protection of marine mammals and others.

4.25 Figure 10 below shows the indicative marine cable route corridor.

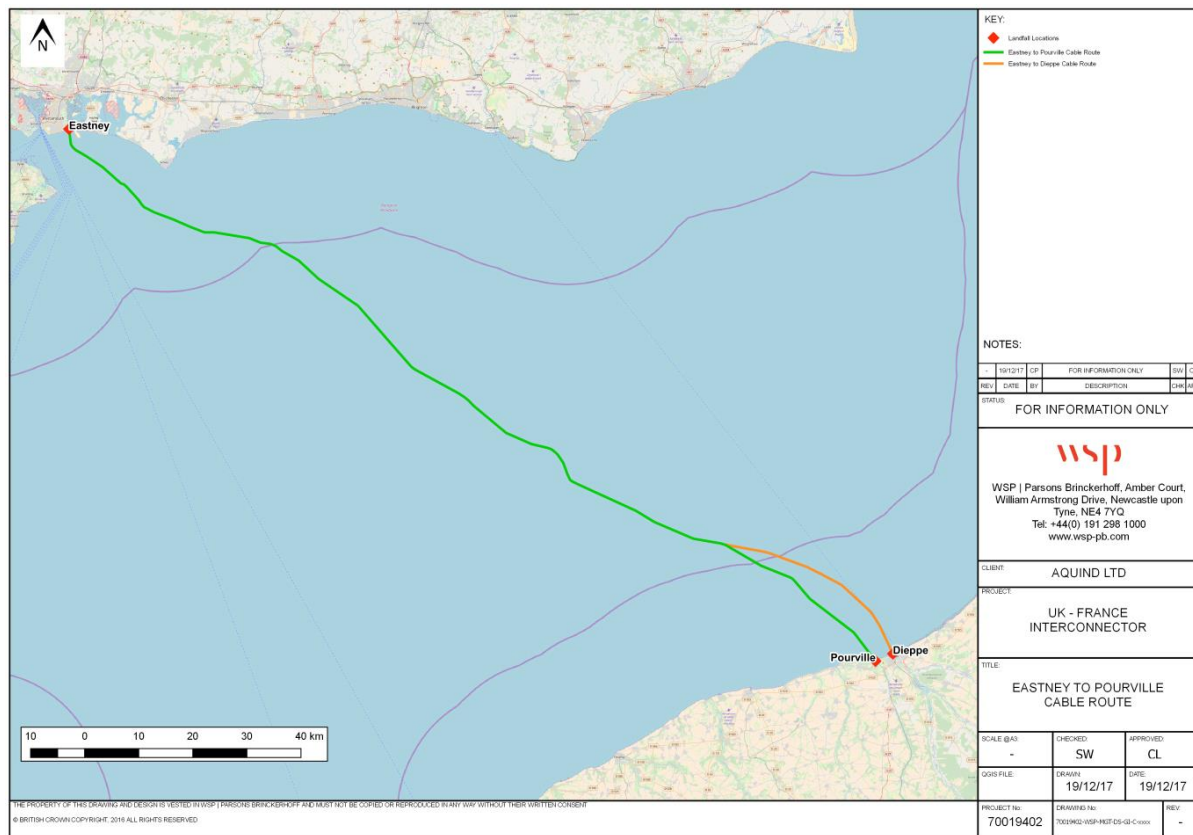

Figure 10 – Indicative marine cable route (green / orange)

5 The permit granting process

Required consents

- 5.1 AQUIND Interconnector will require consents in the UK and France to construct and operate the interconnector.

UK consents

- 5.2 In September 2016, AQUIND obtained an Electricity Interconnector Licence under the Electricity Act 1989 from the energy regulator Ofgem. This licence permits the operation of an electricity interconnector.
- 5.3 AQUIND Interconnector will require authorisation under the Town and Country Planning Act 1990 (as amended), for terrestrial infrastructure, and the Marine and Coastal Access Act 2009.
- 5.4 The UK onshore component of AQUIND Interconnector crosses the administrative areas of four Local Planning Authorities and will require planning permissions from East Hampshire District Council, Winchester City Council, Havant Borough Council and Portsmouth City Council. The project elements located within the boundaries of each Local Planning Authority are shown in Table 2 below.

Table 2 - The project elements affecting each Local Planning Authority

Local Planning Authority	Project elements
Winchester City Council	Converter station (Option B) Cable route
East Hampshire District Council	Converter station (Option A) Cable route
Havant Borough Council	Cable route
Portsmouth City Council	Cable route Landfall

- 5.5 The offshore subsea cables and all infrastructure contained in the area up to mean high water spring (MHWS) tide to the UK/France median line will require a marine licence from the Marine Management Organisation (MMO).
- 5.6 The main consents required from the UK authorities, and the anticipated submission dates of applications, are listed in Table 3 below. Other environmental consents and permits may also be required.

Table 3 – Main UK consents

Component	Consent	Authority	Submission
Converter station	Outline planning permission	East Hampshire District Council (option A) Winchester City Council	Summer 2018
	Reserved matters application	(option B)	Autumn/Winter 2019
Underground HVAC cables	Outline planning permission	East Hampshire District Council Winchester City Council	Summer 2018
	Reserved matters application		Autumn/Winter 2019
Underground HVDC cables	Full planning permission	East Hampshire District Council Winchester City Council Havant Borough Council Portsmouth City Council	Summer 2018
Landfall	Full planning permission	Portsmouth City Council	Summer 2018
Marine subsea cable	Marine licence (UK)	Marine Management Organisation	Summer 2018

French consents

- 5.7 In France, the project will require an Autorisation Environnementale (Environmental authorisation) under articles L181-1 and R181-1 of the Code de l'Environnement. This authorisation will be sought through the submission of an Environmental Statement outlining the likely effects of the project as well as the proposals to avoid, reduce and mitigate these effects. Additionally, the converter station will be the object of a Permis de Construire (building permit) under articles L421-1 and R421-1 of the Code de l'Urbanisme.

6 Potential environmental impacts

Environmental impacts in the UK

- 6.1 The European Directive 85/337/EEC (amended with 2011/92/EU and 2014/52/EU) provides the EU requirements in relation to the assessing of environmental impacts linked to development. The Town and Country Planning (Environmental Impact Assessment) Regulations 2017 (the 'EIA Regulations') and the Marine Works (Environmental Impact Assessment) Regulations 2007 (as amended) (the 'Marine EIA Regulations') give effect to that directive in UK legislation and require an Environmental Impact Assessment (EIA) to be undertaken for developments that fall under Schedules 1 or 2 of the EIA Regulations prior to the grant of consent. Whilst the project is not development within Schedule 1 or 2, EIAs will be undertaken, and Environmental Statements will be submitted to the MMO for the marine components of the project and to the affected Local Planning Authorities for the terrestrial project components. This will be done to identify any likely environmental effects of the project and how these have been adequately mitigated.
- 6.2 The purpose of the EIA is to identify any likely significant environmental effects which may be caused by the project and to detail the mitigation which is to be undertaken to prevent the occurrence of unacceptable environmental impacts. Set out below is a summary of the potential environmental impacts that it is considered may arise as a consequence of the development of AQUIND Interconnector in the UK, which are to be assessed as part of the EIA. This is not a comprehensive list and where necessary in accordance with the relevant regulations other environmental impacts will be assessed.

Terrestrial EIA

Traffic and transport

- 6.3 It is expected that most traffic and transport-related effects will occur during the construction phase. Sensitive receptors would include motorised and non-motorised users of local roads and public rights of way both at the proposed converter station and cable route. Construction traffic may cause some disruption to users of the local road network but every effort will be made to ensure disruption is minimised.

Air quality

- 6.4 Sensitive receptors, including various affected third parties during the construction phase, could include human and ecological receptors around the site boundary and along the construction routes. During construction, these receptors may be affected by dust and Particulate Matter generated during site preparation, and change in local pollutant concentrations (such as nitrogen dioxide) due to emissions from construction vehicles and plant. There are currently no expected effects on air quality during operation of the project.

Noise and vibration

- 6.5 Construction activities may temporarily increase the noise levels at the converter station and along the cable route. Due to the rural location of the converter station, the existing levels of noise at the nearest residential receptor are low. The substation noise levels are dominant near its boundary. The EIA will consider any noise arising from the operation of the converter station. Noise during operation along the cable route is expected to be negligible.

Landscape and visual

- 6.6 There may be landscape and seascape effects arising from construction activities. It is possible there could be some loss of features such as hedgerows and trees, changes in the composition of views from the surrounding residential land and changes to the setting of built assets. These apply to both the converter station and the cable route.

Heritage and archaeology

- 6.7 During the construction phase, there is the potential for some impact on buried heritage assets, some impact on historic hedgerows and temporary effects on the setting of designated heritage assets close to the converter station. During operation, the only potentially significant effect relates to permanent changes to the setting of above ground designated assets in the vicinity of the converter station due to the presence of aboveground structures. Operation impacts on buried archaeological remains are not considered likely to arise, as there is no potential for below ground disturbance following construction.

Ecology (with arboriculture)

- 6.7 Ten European or internationally designated sites are located within 10 km of the project and 11 nationally designated sites are located within 2 km of the project. There is 72.79 ha of woodland listed on the National Inventory of Woodland and Trees and there are 13 types of Priority Habitat present within 1 km of the project. There is also the potential for bats, badger, otter, water vole, dormouse, breeding birds, wintering and passage birds, reptiles, great crested newt and invertebrates to occur within the project area. The impact on these habitats and species will be assessed in the EIA.

Socio-economics

- 6.8 During construction there may be a direct, indirect and induced effects on employment associated with spending in the local economy by contractors. There may also be changes in the amenity value for users of recreational / open space, public rights of way and non-designated public routes during operation and construction. These will be assessed in the EIA. Other socio-economic effects are not likely to be significant and are not proposed to be assessed in the EIA.

Water resources and flood risk

- 6.9 The project is in proximity to water courses, land drains and ponds. It is located within a principle aquifer and Inner Zone 1 Source Protection Zone (the 50 day travel time

from any point below the water table to the source; this zone has a minimum radius of 50 m). In addition, the southern section of the cable route is located within and in close proximity to land identified to be at risk of surface water flooding. Thus, the impacts on surface water and groundwater features and the impacts on flooding will be assessed in the EIA.

Ground conditions

- 6.10 Land may have become contaminated through previous industrial or agricultural practices. Contaminated land may be encountered which may cause environmental harm or adverse health effects during construction and operation if not properly managed. Remediation of any contaminated land encountered will require treatment and/or disposal of contaminated materials. Along the cable route, there may be areas of land that have special geological significance. These areas of land could be affected.

Carbon and climate change

- 6.11 A greenhouse gas assessment is proposed to be undertaken as part of the EIA. A climate resilience assessment is also proposed to identify how the changing climate may affect the project in terms of construction and operation of the infrastructure, its ability to function and the end users.

Human health

- 6.12 There are some residential properties in proximity to the project. The project could give rise to beneficial and adverse impacts including employment from construction jobs and a reduction in amenity resulting from landscape impacts respectively. The cable route will potentially be associated with indirect negative impacts brought about by increased congestion during cable laying works and noise during construction.

Soils and land use

- 6.13 Agricultural land quality, soil resources and local farm businesses could be affected by the project. This could include loss of protected agricultural land, as the converter station will be built on agricultural land, loss of or damage to the soil resources and adverse impacts on the viability of farm holdings because of the potential loss of land.

Electric and magnetic fields

- 6.14 The project will use both AC and DC technologies (as explained in the project description). This means that both AC and static electric and magnetic fields will be produced. The EIA will assess both these fields. There will be no external electric fields associated with the underground AC and DC cables as their design includes a metal sheath so the public will not be exposed to the electric fields. Electric and magnetic fields around the converter station would originate from the circuits crossing the boundary and from the converter station equipment within the boundary. The field will strengthen at the converter station boundary due to the cables crossing the boundary but will be within the appropriate guidelines.

Waste and material resources

- 6.15 The impacts of the project from materials, waste generation and disposal are likely to occur on-site and off-site. Most direct and indirect impacts will occur during construction and the first full year of operation. These include consumption and reduction in consumption of natural and non-renewable resources and generation and disposal of waste.

Marine EIA

Physical environment

- 6.16 The EIA will include an assessment of the effects produced by physical disturbance to seabed geology during cable installation works and any effects associated with operating of the interconnector. The proposed cable route crosses and, for a short section in the Portsmouth area, runs adjacent to Langstone Harbour which is designated as a Ramsar Site, Site of Special Scientific Interest (SSSI), Special Area of Conservation (SAC) and Special Protection Area (SPA). As the Solent Maritime SAC is located in close proximity to the proposed landfall at Eastney, any the potential impacts of landfall in this location will be assessed upon the designated features of this SAC, as well as those for the Langstone Harbour designation. The EIA will also contain an assessment of impacts on local sediment regimes. The project is considered unlikely to impact upon coastal processes; assessments are likely to be desk based, use existing data and not require the deployment of metocean equipment. In terms of water and air quality, no significant environmental impacts are expected.

Seabed environment

- 6.17 The EIA will assess activities that will cause disturbance of the seabed. The EIA will also assess the impact of displaced and disturbed sediment. It is not anticipated that disturbed contaminated sediment, the risk of any introduction of invasive non-native species during the installation or electro-magnetic field emissions during operation, will cause any significant environmental effects.

Fish and shellfish

- 6.18 The EIA will contain an assessment of impacts on fish and shellfish associated with temporary habitat disturbance from cable installation, works near a river mouth, noise and vibration and electro-magnetic fields. The cable burial and associated works may also cause a temporary increase in suspended sediment in the water column. These potential impacts and appropriate mitigation will be outlined in the EIA.

Birds

- 6.19 The EIA will assess the potential to disturb and displace birds during construction of the cable. It will also consider indirect effects as a consequence of the impact on habitats, benthic organisms and fish species during construction; prey disturbance during operation and effects of the risk of exposure to contaminants such fuel accidentally released from vessels will also be assessed. Potential collision risk and

barrier effects to seabirds are not relevant to subsea cables and it is proposed not to include these effects in the EIA, as they are very unlikely to be significant.

Marine mammals

6.20 The potential effects on marine mammals are limited to those arising from the installation of the cable and no effects are anticipated during its operation. The number of vessels required during the installation activities is not anticipated to significantly increase the vessel traffic within the Channel, therefore the risk of collision with vessels has been scoped out of the EIA. Increased noise from vessels during construction and operation of the cable is not considered to result in significant environmental effects. However, the effect of noise from the geophysical survey and positioning equipment which emits sound during the installation process (for example sonars) will be assessed. The EIA will assess any effects of the discovery of unexploded ordinance (UXO) requiring in situ detonations could have on marine mammals and outline appropriate mitigation through the relevant guidelines.

Commercial fisheries

6.21 The potential for temporary loss of, or restricted access to, fishing grounds, temporary displacement of fishing activities, and interference with normal fishing activities will be assessed in the EIA. Further, safety issues for fishing vessels, temporary increases in steaming times and obstacles on the seabed will all be considered. This relates to both the installation and operation of the cable.

Shipping and navigation

6.22 Due to its location, it is not possible for the cable route to avoid all active commercial navigation areas. Nevertheless, the route of the cable corridor has been selected with careful consideration given to constraints. Impacts that will be assessed include deviation from established vessel routes and displacement of recreational activity; a potential increased risk of a vessel-to-vessel collision due to installation vessel activity and an increase in the risk of interaction with vessel anchors and displacement of anchoring activity. Potential effects that will be considered also include displacement of fishing vessels into commercial shipping lanes; displacement of third party marine activities; a reduction in under keel clearance resulting from laid cable and associated protection; and interference with marine navigational equipment.

Other marine users

6.23 Other marine users that have the potential to be affected by the cable include the military, aggregates, offshore windfarms, recreational users and infrastructure. Potential effects on these users are similar to those on shipping and navigation, and will be considered within the EIA.

Maritime cultural heritage

6.24 Archaeological and cultural heritage assets located within the UK section of the proposed marine cable corridor fall into four fundamental categories: seabed prehistory; maritime archaeology; aviation archaeology; intertidal heritage assets and marine installations. Other themes relevant to the archaeological baseline of the

project include the setting of known marine heritage assets and the historic seascape character of the area. Any potential damage to or destruction of known and unknown assets during cable construction and operation will be considered within the EIA.

Landscape and seascape

- 6.25 Effects beyond the mean high water springs (MHWS) will be limited to the cable installation where the use of heavy plant and installation vessels may be visible from the shore. There may also be some visible ground disruption in the intertidal area. These visual effects will occur briefly during installation phase. The effects on the intertidal area will also be short term. These effects will be assessed as part of the landscape and visual impact assessment in the terrestrial EIA, and cross-referenced within the marine EIA.

Environmental impacts in France

- 6.26 As the environmental surveys to be undertaken in France are still at an early stage, this version of the Non-Technical Summary does not contain details of the environmental impacts in France, although the matters to be considered are likely to be similar to those set out above. As the project development progresses, further details will be included in future revisions of this document.

Cumulative and cross-boundary impacts

- 6.27 Potential cumulative and cross-boundary impacts will be assessed for each set of permit applications, and an overall assessment will also be produced to describe the environmental impacts of AQUIND Interconnector as a whole.

7 Consultation

Approach to consultation

- 7.1 The onshore and the offshore elements of AQUIND Interconnector will be consented by separate bodies and pursuant to different legislative frameworks. It should be noted that there is an area of crossover between the onshore and offshore consenting regimes, with the area between the mean low water mark and the mean high watermark, known as the intertidal area, being subject to both.
- 7.2 AQUIND is fully aware of the benefit of undertaking early and comprehensive pre-application consultation with all relevant stakeholders and persons and considers consultation to be of vital importance to the success of this project.
- 7.3 In terms of the approach to consultation, in accordance with Article 9(3) of the TEN-E Regulation, AQUIND has prepared a Concept for Public Participation which sets out
- the stakeholders concerned and addressed;
 - the measures envisaged, including proposed locations and dates of dedicated meetings;
 - the timeline; and
 - the human resources allocated to the respective task.
- 7.4 The Concept for Public Participation in the UK is available on the project consultation website <https://aquindconsultation.co.uk>.
- 7.5 For France, materials for public consultation will be produced and published on the French consultation website. The web address of this website will be made available in future revisions of this Non-Technical Summary once the French website goes live.

Approach to consultation in the UK

- 7.6 AQUIND will consult stakeholders and communities who are potentially affected by, or interested in, either or both of the UK Onshore and UK Offshore elements of AQUIND Interconnector. In broad terms, the relevant stakeholders and communities who could be affected by AQUIND Interconnector are those who live or work in the vicinity of the proposed development. Indicative details of the entities to be consulted are set out in Table 4.

Table 4 – Stakeholders/Amenity Groups that are being consulted in the UK

Consultee	Mechanism for Consulting	Onshore / Offshore
Relevant District / Borough Council, Unitary Authorities & County Councils, specifically: <ul style="list-style-type: none"> - Hampshire County Council - Portsmouth City Council - East Hampshire District Council - Havant Borough Council - Winchester City Council 	Pre-application meetings with planning officers are ongoing and are expected to continue throughout the pre-application process. We will also be actively sharing information and consulting elected members at relevant authorities through a combination of written materials, telephone and face-to-face discussions, events and online materials.	Onshore
Marine Management Organisation (MMO)	Via postal, electronic and telephone correspondence, supplemented with face-to-face meetings, as required.	Offshore
Members of Parliament	Via postal, electronic and telephone correspondence, supplemented with face-to-face meetings, as required.	Onshore + Offshore
Department for Business, Energy & Industrial Strategy / Relevant Government Ministers	Via postal, electronic and telephone correspondence, supplemented with face-to-face meetings, as required.	Onshore + Offshore
Environment Agency	Via postal, electronic and telephone correspondence, supplemented with face-to-face meetings, as required.	Onshore + Offshore
Natural England	Via postal, electronic and telephone correspondence, supplemented with face-to-face meetings, as required.	Onshore + Offshore
Historic England	Via postal, electronic and telephone correspondence, supplemented with face-to-face meetings, as required.	Onshore + Offshore
Centre for Environment, Fisheries and Aquaculture (Cefas)	Via postal, electronic and telephone correspondence, supplemented with face-to-face meetings, as required.	Offshore
Ofgem	Via postal, electronic and telephone correspondence, supplemented with face-to-face meetings, as required.	
Other Statutory Consultees	Via postal, electronic and telephone correspondence, supplemented with face-to-face meetings, as required.	Onshore + Offshore
Parish Councils	Via postal, electronic and telephone correspondence, supplemented with face-to-face meetings, as required. We will also be inviting Parish Councils to attend a public exhibition event in their local area.	Onshore

Landowners	Via postal, electronic and telephone correspondence, supplemented with face-to-face meetings, as required.	Onshore
Interest / Third Party / Community Groups	Via postal invitations to attend a public exhibition in their local area and, where appropriate, through involvement in the Community Liaison Group. Additional consultation will include postal, electronic and telephone correspondence, supplemented with face-to-face meetings with local interest / third party / community groups, as required.	Onshore + Offshore
Members of the public and/or businesses situated in the vicinity of any cable route options / landfall locations / converter station locations	Via postal invitations to attend a public exhibition in their local area. The invitations will also include contact details should they wish to request further information. The project website, freephone information line, consultation email address and freepost response service will provide further mechanisms for ongoing participation from local residents and businesses.	Onshore
Fishermen	Face-to-face meetings, supplemented with via postal, electronic and telephone correspondence.	Offshore
General Public	Via the project website and local media coverage and/or media advertising. The project website will remain operational for the duration of the pre- and post-application process and will include details of the public consultation events. The project website, freephone information line, consultation email address and freepost response service will provide further mechanisms for ongoing participation from the wider public.	
Other stakeholders identified by the Local Planning Authority	To be agreed, but likely to be based on the mechanisms detailed above.	

Consultation events

7.8 AQUIND will also host a series of public exhibitions displaying its proposals to the wider community. The purpose of these events is to present the proposals, respond to questions and register feedback prior to submitting a planning application. These are due to take place at 2-8pm on:

- Wednesday, 24 January 2018 - Waterlooville Community Centre, 10 Maurepas Way, Waterlooville, PO7 7AY
- Friday, 26 January 2018 - Milton Village Community Hall, 182 Milton Road, Southsea, Hants, PO4 8PR
- Saturday, 27 January 2018 - Lovedean Village Hall, 160 Lovedean Lane, Waterlooville, PO8 9SF

- 7.9 In addition to the above, two initial meetings have been held in October 2017 with UK fishermen affected by marine survey works.

Approach to consultation in France

- 7.10 Public consultation in France will commence in early 2018 (to align with the UK programme). Initially, the public will have an opportunity to comment on the proposals via the French consultation website. This will be followed by more formal consultation which will include exhibitions, meetings with key stakeholder groups, and other events. The exact details of the formal consultation will be agreed with the relevant authorities in France.

8 Project status and next steps

- 8.1 At the time of publishing (December 2017), requests for EIA Scoping Opinions to the Marine Management Organisation for the proposed marine works and to the affected UK Local Planning Authorities for the proposed terrestrial works are under preparation. The EIA Scoping Opinions are expected to be issued in early 2018.
- 8.2 A number of terrestrial environmental surveys, such as arboricultural surveys, have been completed in the UK. Other surveys such as transport surveys as well as terrestrial ground investigation works are scheduled for late 2017 / early 2018.
- 8.3 Marine benthic surveys have been completed in the UK waters. Geophysical and geotechnical marine surveys are scheduled for late 2017 / early 2018.
- 8.4 In France, the optioneering process to determine the final landfall site and terrestrial cable route is ongoing. Further environmental surveys will be undertaken in late 2017 / 2018.
- 8.5 A project timeline including the submission dates for consent applications, the anticipated dates of determination and the expected dates for the beginning of construction will be included in future revisions of this document.
- 8.6 Award of PCI status is expected in January 2018.
- 8.7 The English and French project websites, as well as this document, will be updated regularly to reflect the current status of the project.

